

# RESISTOR TEST PROJECT: PART 2 - TEST JIG VERIFICATION RESULTS

Developed with support from:



Audio Builders Workshop

<https://www.audiobuildersworkshop.com/>

Rev 3.0 24-Feb-18

## CONTENTS

Summary.....	6
AP channels .....	6
Agreement in values when measuring noise.....	6
Background.....	7
Rev 3 note.....	7
AP515 residual noise .....	7
Unbalanced input .....	7
Analysis: AP Noise on unbalanced input.....	10
Balanced AP noise check .....	11
Validating the test jig.....	12
Analysis: Reference resistor noise .....	13
Comparison of AP515 and AP555.....	13
Measurement of resistors connected to the AP input .....	15
10 K carbon film (leaded 1/4W), manuf unknown .....	15
Analysis: 10K Carbon film .....	16
10K wirewound.....	16
Analysis: 10K wirewound.....	17
Measurement of resistors connected between AP output and AP input .....	17
Component THD+N.....	19
Analysis.....	20
Test fixture noise measurement.....	20
With bridge board shorted .....	20
Power supply noise check.....	21
RREF noise measurement.....	21
Analysis: RREF 2.5K excess noise .....	25
Excess noise measurement with AC applied .....	25
Op amp validation .....	26
Performance check.....	27
Analysis: op-amp verification board.....	29
Summary.....	29
References .....	30
Appendix A.....	30



Figure 1 Input shorted setup with small jig (jig on the right also used for component test) .....8

Figure 2 With HPF engaged input shorted unbalanced (amplitude plot, no smoothing).....8

Figure 3 With HPF off (DC input mode) input shorted unbalanced showing lower 1/f noise than AC coupled (amplitude plot, no smoothing).....9

Figure 4 DC coupled 1/24 octave smoothed ASD from FFT results with unbalanced inputs shorted .....9

Figure 5 RMS levels with unbalanced input shorted (45 kHz BW, AC coupled) – unbalanced. 5 Sec (0.2 Hz) filter....10

Figure 6 Amplitude plot of FFT results. Balanced inputs. Ch1 out to in through two 5’ Blue Jeans cable, ch 2 shorted at input. No smoothing.....11

Figure 7 ASD and smoothing applied to data from Figure 6.....11

Figure 8 RMS levels for balanced inputs. Ch1 out to in, ch 2 shorted (input filter set to AC) .....12

Figure 9 Ch1 residual noise of DUT bridge shorted. 128K pt FFT 128 averages and no further processing.....12

Figure 10 Data from Figure 9 plotted as ASD and smoothed. ....13

Figure 11 AP555 and AP515 instrument noise floors with input shorted PSD comparison (128K pt FFT 128 averages) (rev 3) .....14

Figure 12 FFT results of 10K carbon film ch 1, ch 2 input shorted (unbalanced, using the small test jig).....15

Figure 13 Smoothed ASD of 10K (ch 1) from Figure 11 .....16

Figure 14 Smoothed ASD of Ohmite 10K Wirewound on input #1 (BNC small test jig) .....17

Figure 15 AP loopback (internal) .00088% THD+N (-101 dB) 100 k termination .....18

Figure 16 Small test jig AP loopback (blue) (.00082% THD+N, -102 dB) vs. input shorted (red) 100 k termination ...18

Figure 17 Small test jig loopback comparing 100K and 600 ohm termination. 128K point FFT, 16 averages. Linear frequency scale.....19

Figure 18 2.5K ohm Wirewound in between the AP output and input. ....20

Figure 19 Noise check from batteries – none observed .....21

Figure 20 RMS level vs time for the RREF, left side no power, right side power applied around the 12 second mark (ch 2 is AP input shorted) .....22

Figure 21 Comparison of AP515 AC vs DC coupling. Dashed line is ch2 – AP input shorted. Unprocessed 128K point FFT. ....23

Figure 22 RREF unpowered (ch 1) and AP input shorted (ch2) (balanced connection to test jig) raw FFT results .....23

Figure 23 RREF unpowered (ch 1) and input shorted (ch2) (balanced) 32K FFT with 512 averages (small FFT size results in DC showing below 20 Hz).....24

Figure 24 Increase in RREF 1/f noise with 17.4 VDC applied to bridge. Smoothed ASD results. (128K pt FFT).....24

Figure 25 Scope trace of RREF bridge output with 18.5V applied .....25

Figure 26 Spectrum using 1 kHz instead of DC for the bridge (128 K pt FFT, 128 averages).....26

Figure 27 Frequency sweep .....28

Figure 28 200 mV RMS input. 128 k pt FFT, 16 averages (AC coupled) NE5532 and wirewound resistors.....28

Figure 29 128K pt FFT 128 averages gen off.....29

Figure 30 Op-amp board configured for design validation .....30

Please see the Summary document for a list of abbreviations and revision notes, and part 1 for a list of references.

## SUMMARY

This document records the measurements made to validate the test setup. The validation was done using an AP515 with version 4.5 software. Parts of this will be repeated when the AP555 is used.

Unless noted otherwise AP515 setup is as follows:

- AP515 input set to 100 k ohms (200 k ohms for balanced)
- 96K sample rate (provides a 45 kHz equivalent bandwidth)
- Input filter: DC for FFT, AC for RMS measurements
- Weighting & EQ: None
- Blue Jeans 6' cable with Neutrik connectors and Canare L-4E6S cable
- FFT 128K points AP-equiripple window. 128 averages unless otherwise indicated. 1/24 octave smoothing. ASD plotting.

With the input high pass enabled there appears to be more DC offset (or 1/f noise); at 5 Hz the level is 50 nV with the filter and 35 nV without with the input shorted.

Ideal noise calculations from <http://www.daycounter.com/Calculators/Thermal-Noise-Calculator.phtml>

Wirewound resistors are Ohmite non-inductive WN series.

### AP CHANNELS

On the test jig channel 1 is the RREF (2.5 k) bridge used as a measurement verification. Unfortunately on the AP515 being used channel 2 was the noisier channel, so the decision was made to place the RREF on channel 2 of the AP and the DUT on channel 1. This is opposite the labeling on the test jig.

### AGREEMENT IN VALUES WHEN MEASURING NOISE

There is no single value that can describe noise. As an approximation average values calculated in a variety of methods are used in the presented analysis. Averaging for longer periods generally produces a better estimate, but operator boredom quickly sets in after a couple of doublings of measurement repeats. In some cases values are estimated from plots using the AP's measurement cursors. There is also some variability associated with the equipment and the fixtures. For the purposes of this paper good agreement between different methods of calculating values would be taken to be within +/- 10% of each other.

## BACKGROUND

The normal figure of merit for a resistor's noise is the excess noise, i.e. noise over the theoretical Johnson noise. The figure of merit is described by a noise index, which is the measured RMS noise with a voltage applied to the resistor. 0 dB is referenced to the value of 1 uV/Volt. This noise voltage is only measured across one decade of frequency. See *Smith* or *Vasilescu* for more background (or just google excess noise). See *Seifert* for the use of a Wheatstone bridge for noise measurement.

## REV 3 NOTE

Originally the plan was to analyze both noise and distortion. However the noise measurement work expanded enough that it was decided to leave a distortion investigation for a separate effort. The initial work though did look at the testing for THD+N and those results are retained in this document as it does validate that the fixture and methodologies are correct in a general sense.

Likewise there was a plan to measure the noise and distortion on actual circuits; again after looking at the depth of the noise study it was felt best that this would be a topic of its own. The initial validation work was retained in the final version of this document.

## AP515 RESIDUAL NOISE

The FFT plots are presented in Rev 2 with additional processing to increase readability and avoid the need to convert the noise floor level reported by the FFT to an ASD (Amplitude Spectral Density) plot as explained in part 1. With the 128K point FFT there's enough hair in the higher frequency ranges that presenting them with smoothed results for noise measurements is beneficial. This works well as long as there are no tones present in the signal. Plots of THD are presented without smoothing.

## UNBALANCED INPUT

Initially tested with the input shorted using the small test jig with wire jumpers.

The 1 kHz tone and harmonics observed in some of the plots (see for example Figure 2 or Figure 3) is from the laptop attached to the AP. It appears randomly but apparently can be prevented by running the laptop from batteries, which was done when measuring total noise. No further attempt was made to determine an alternate method to break up an apparent<sup>1</sup> ground loop.

Harmonics of 60 Hz appear in some of the plots, including with the AP input shorted. They are at very low levels and were deemed to not be a problem for the initial test jig verification.

---

<sup>1</sup> Apparent in the sense that 1 kHz would appear to be an unusual frequency to have floating around randomly from a laptop.

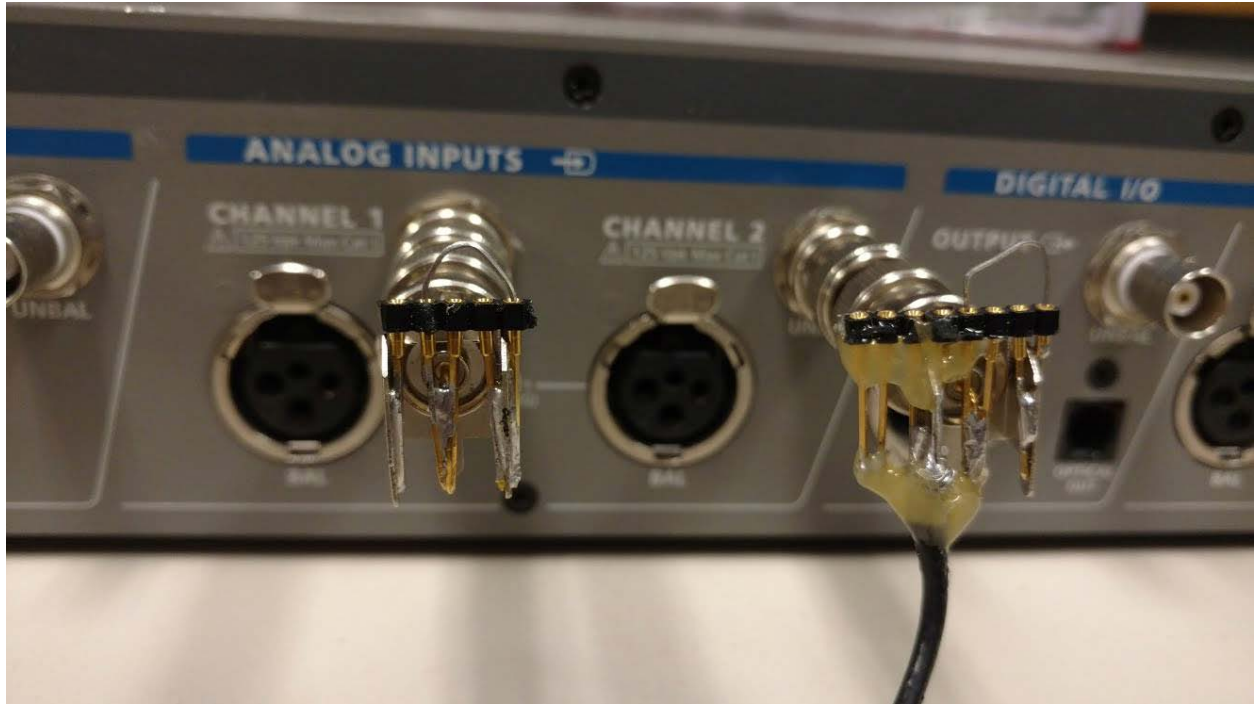

Figure 1 Input shorted setup with small jig (jig on the right also used for component test)

Measurements for the FFT were done with 128K point FFT, please see the figure notes for other details as some are using level for the Y axis and some are using ASD (Amplitude Spectral Density) and/or smoothing. RMS versus time plots (for example Figure 5) are with 16 readings/second with the 0.2 Hz filter and averages computer over 30 seconds of data.

The RMS noise level for the unbalanced inputs for chann1 1 is 1.60 uV and for channel 2 is 1.63 uV.

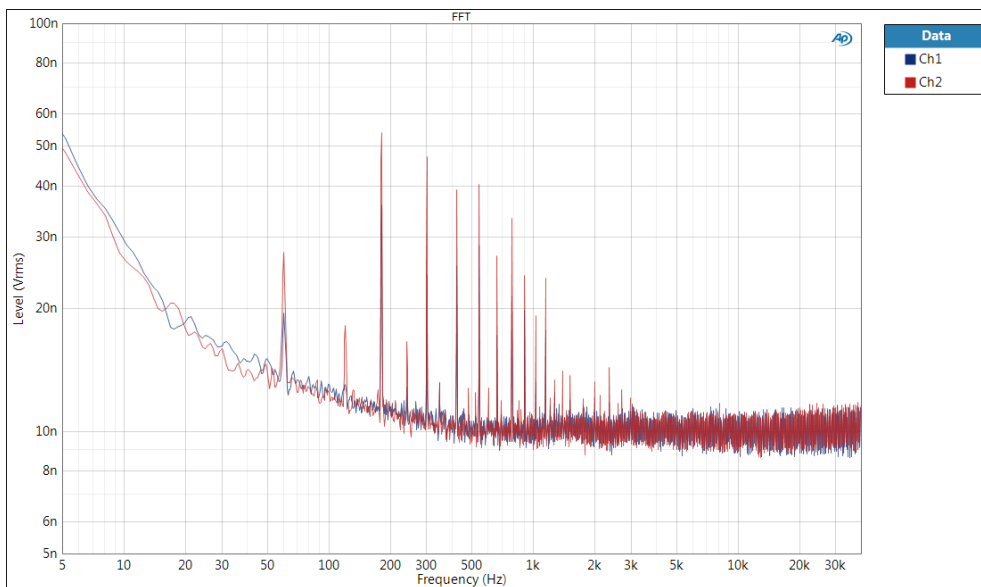

Figure 2 With HPF engaged input shorted unbalanced (amplitude plot, no smoothing)



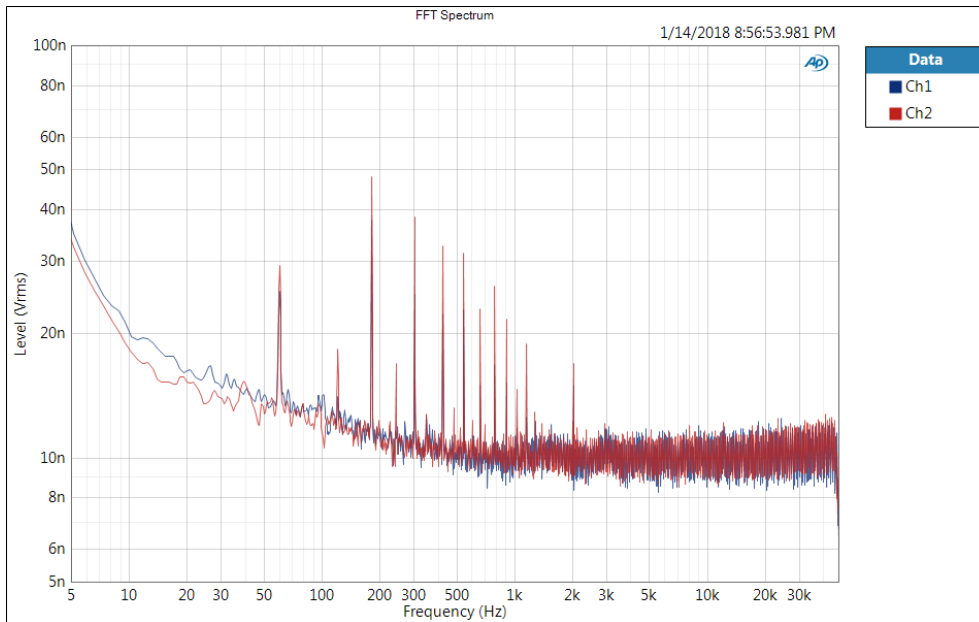

Figure 3 With HPF off (DC input mode) input shorted unbalanced showing lower 1/f noise than AC coupled (amplitude plot, no smoothing)

The data in Figure 3 can be displayed as an amplitude spectral density plot to directly read values that are used to calculate the RMS noise level (see *Trump* paper previously referenced). Smoothing can also be used to simplify determining the Johnson noise. The results of this are shown in Figure 4. The values of the 60 Hz harmonics are no longer correct in absolute terms; Figure 3 should be used to read their levels from.

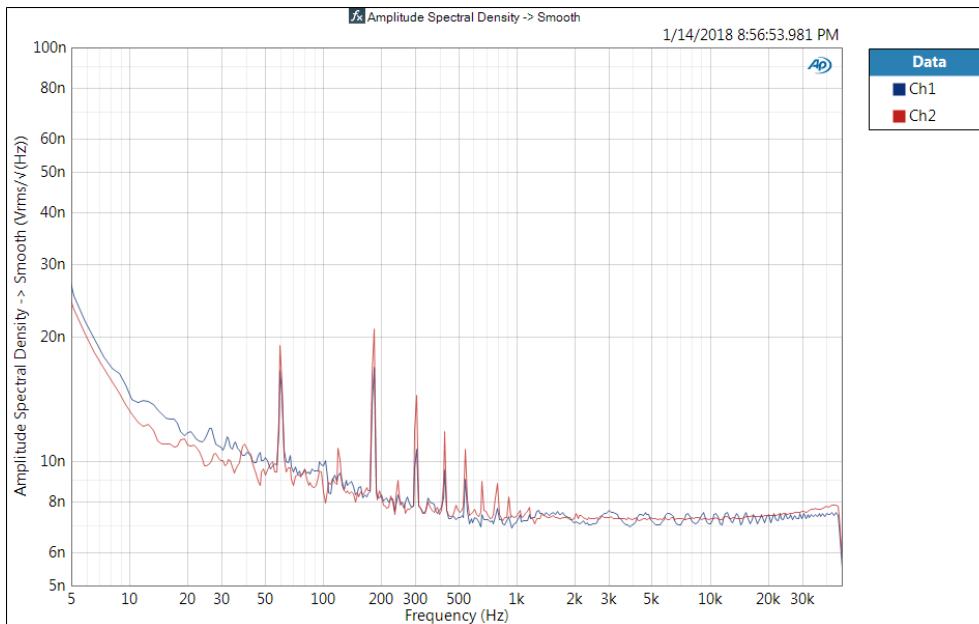

Figure 4 DC coupled 1/24 octave smoothed ASD from FFT results with unbalanced inputs shorted.

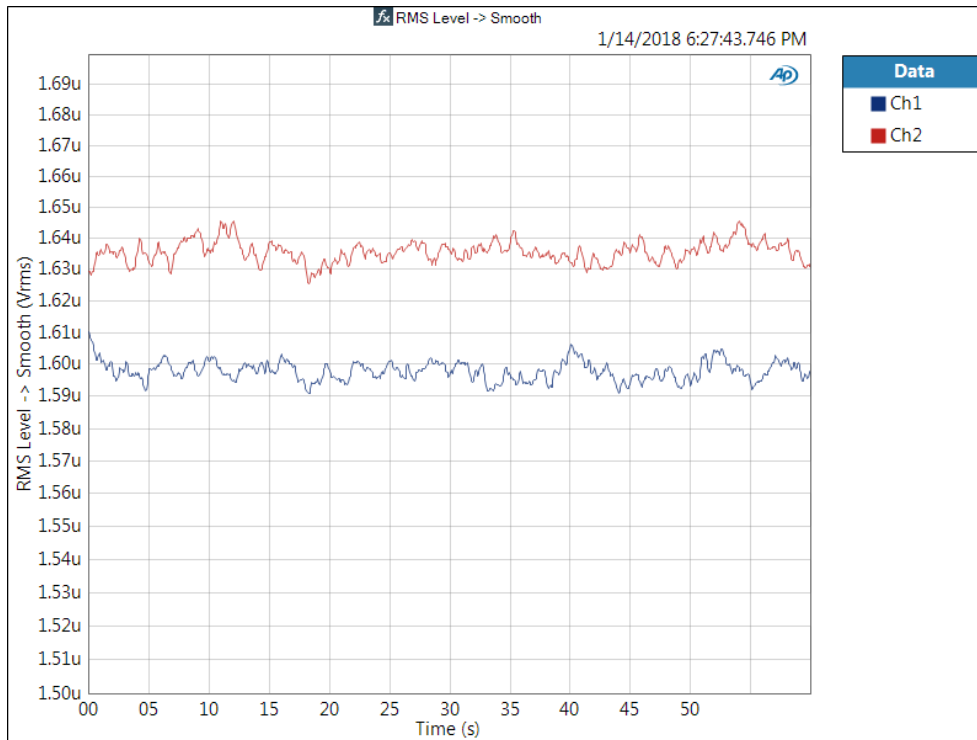

Figure 5 RMS levels with unbalanced input shorted (45 kHz BW, AC coupled) – unbalanced. 5 Sec (0.2 Hz) filter.

#### ANALYSIS: AP NOISE ON UNBALANCED INPUT

The contribution from the  $1/f$  noise is minor, about 1% (as calculated using the spreadsheet referenced in *Trump*). With the baseline noise floor of about 10 nV (amplitude, as estimated from Figure 3), this translates to 7.2 nV/rt-Hz (estimated from Figure 4) yielding a total noise amplitude in the 45 kHz measurement bandwidth of 1.65  $\mu$ V RMS. This is in good agreement given the uncertainties associated with measuring noise via estimating from the plots with the value reported by the AP of 1.60  $\mu$ V RMS.

With respect to measuring excess noise and using the measurements of Figure 3 then for the frequency decade from 10 Hz to 100 Hz the contribution from  $1/f$  noise is .072  $\mu$ V RMS. This can be calculated as follows (the AP does this calculation, this is meant to be illustrative of the procedure described in part 1:

- At 10 Hz the level is 20 nV RMS (from the FFT plot)
- Correcting for the FFT and window (.761) the spectral density is 15.2 nV/rt-Hz at 10 Hz
- Plugging 10Hz to 100 Hz and 15.2 nV/rt-Hz at 10 Hz to the spreadsheet (*Trump*) and calculate the  $1/f$  noise in a frequency decade, yielding .072  $\mu$ V RMS.

In the bridge configuration with 18V applied a measured value of .072  $\mu$ V RMS would correspond to 0.004  $\mu$ V/V, which is a noise index of -48 dB. The parts of interest are expected to have noise indexes below -40 dB so the AP515  $1/f$  noise will be a consideration for the best parts. Another limiting factor may be the general noise floor. At 100 Hz the noise power from  $1/f$  and Johnson noise of the AP515 are equal.

BALANCED AP NOISE CHECK

In Figure 6 the channel 1 data represents the AP output connected through two 5’ Blue Jeans (Canare wire) XLR cables plugged end to end to the channel 1 input to represent the minimal noise using the AP as the source.

Channel 2 is operated with input shorted. As done with the other FFT plots the input filter is set to DC. Note that smoothing was disabled to show the 60 Hz harmonics as very narrow lines. In Figure 6 the plot level on the Y axis, not ASD. Figure 7 shows the same data in ASD and smoothed. As can be seen the generator does contribute a small amount of noise.

The peak at 33 Hz on channel 1 does not have an obvious explanation other than it’s associated with the AP. If the cable is unplugged from the AP output and instead a shorting plug is attached the 33 Hz is no longer present.

The noise levels using the 16 readings/sec for 30 seconds with 0.2 Hz filtering are shown in Figure 8. This corresponds to an average value of 1.82 uV RMS for channel 1 and 1.65 uV RMS for channel 2.

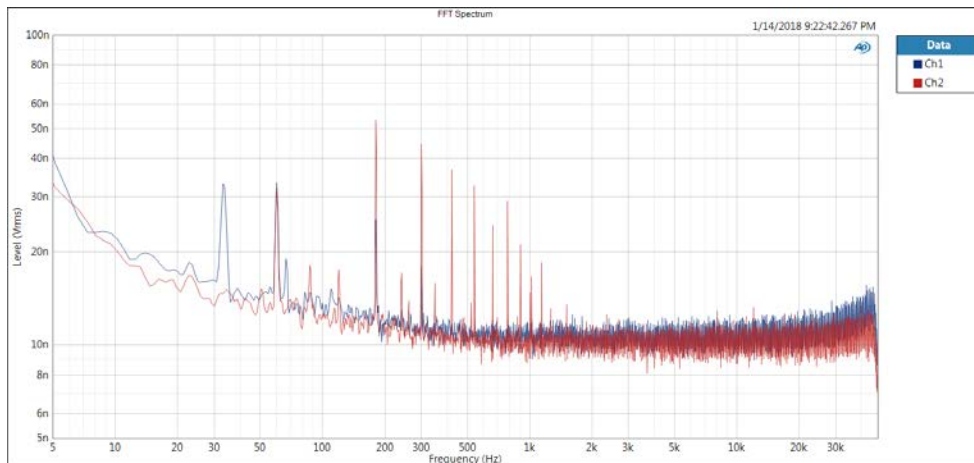

Figure 6 Amplitude plot of FFT results. Balanced inputs. Ch1 out to in through two 5’ Blue Jeans cable, ch 2 shorted at input. No smoothing.

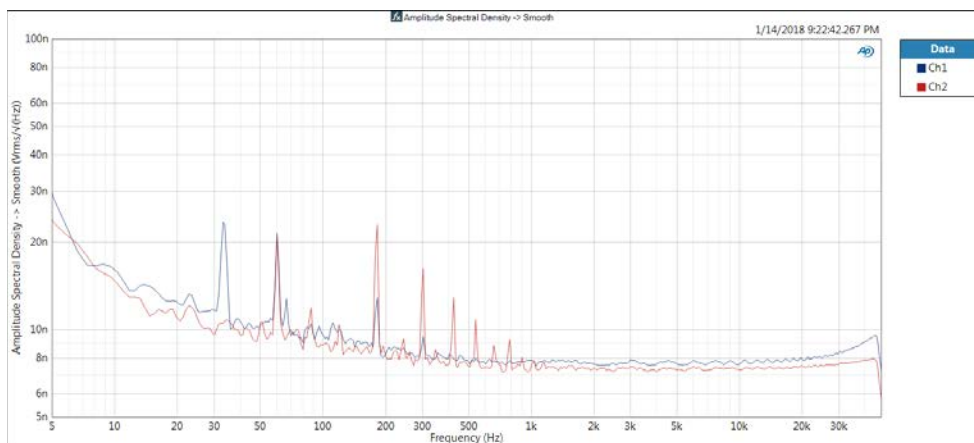

Figure 7 ASD and smoothing applied to data from Figure 6

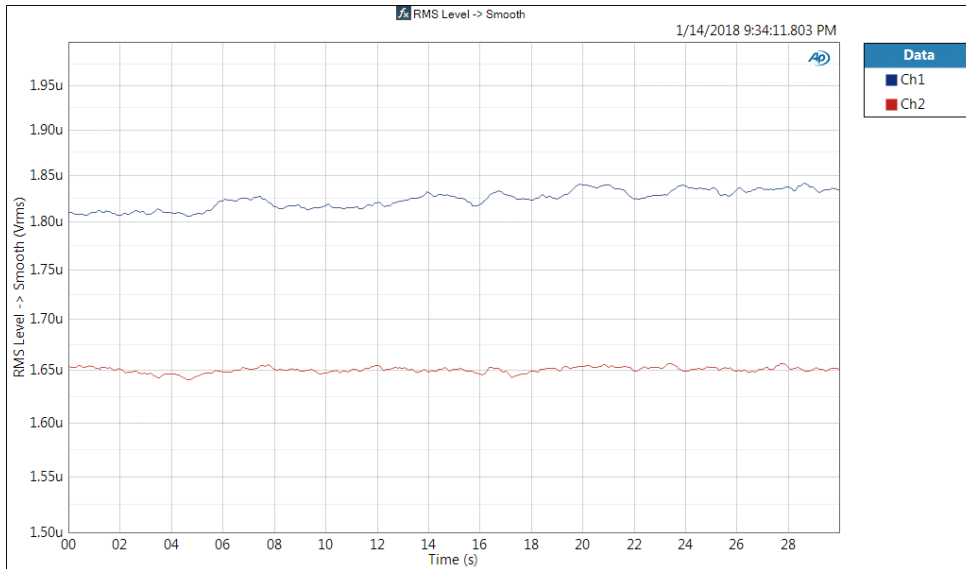

Figure 8 RMS levels for balanced inputs. Ch1 out to in, ch 2 shorted (input filter set to AC)

VALIDATING THE TEST JIG

Having now characterized the AP and the cables, the actual test jig noise was checked next.

In the next set of measurements 6’ Blue Jeans XLR cable was connected to the test jig following the measurement convention of channel 1 being the DUT and channel 2 being the 2.5K wirewound resistor reference.

The shorted DUT bridge measured 1.61 uV RMS noise versus the 1.60 uV measured with the AP input shorted, indicating only 10 nV RMS of additional noise from the fixture and cabling. The RREF bridge measure 2.14 uV RMS versus a value of 2.12 uV that is calculated for AP noise of 1.64 uV RMS and resistor noise of 1.35 uV RMS.

For Figure 9 and as on other plots a 128K point FFT for 128 averages was used. Smoothing was not applied, and the Y axis is amplitude, not ASD.

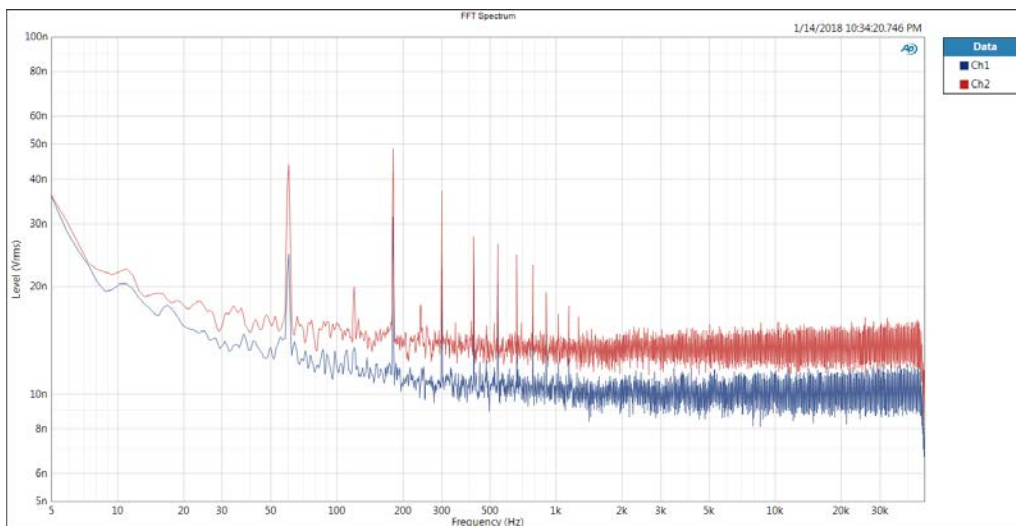

Figure 9 Ch1 residual noise of DUT bridge shorted. 128K pt FFT 128 averages and no further processing.

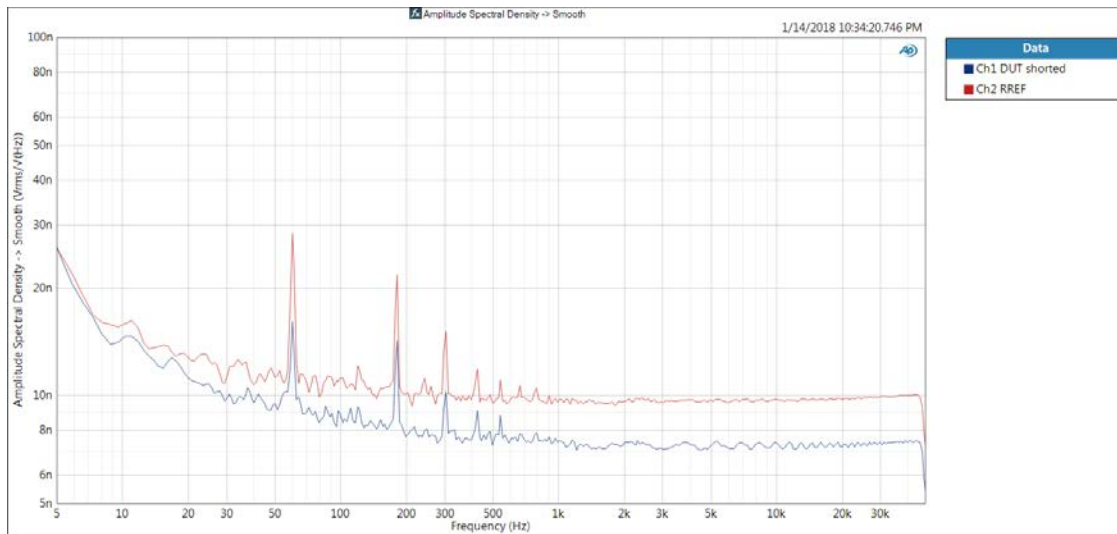

Figure 10 Data from Figure 9 plotted as ASD and smoothed.

#### ANALYSIS: REFERENCE RESISTOR NOISE

The AP's floor of 10 nV in the FFT of Figure 9 corresponds to 7.3 nV/rt-Hz of Figure 10 (see Part 1 for the derivation of the correction factor of .761 in the specific FFT configuration being used).

A 2.5 K ohm resistor has Johnson noise of 6.36 nV/rt-Hz. The RMS total of the AP plus resistor noise is 9.9 nV/rt-Hz, again in reasonable agreement with the AP measured value taken from the plot in Figure 10.

The 1/f noise does not change from the prior calculations (i.e. compare Figure 7 and Figure 10) as there's no DC voltage applied, also see Analysis: AP Noise on page 10.

#### COMPARISON OF AP515 AND AP555

An input shorted test was run on a recently factory calibrated AP555. The next figure compares the results of the two instruments. Discussion of the results follows the figure, but please note the frequency axis has been modified to show 2 Hz to 2 kHz.

The plots used for comparing with the AP555 were done as Power Spectral Density (PSD) plots; the same range as the other plots is contained in this plot. The relationship is:

$$-160 \text{ dB V}^2 / \text{Hz} = 10 \text{ nV rt-Hz}$$

$$-140 \text{ dB V}^2 / \text{Hz} = 100 \text{ nV rt-Hz}$$

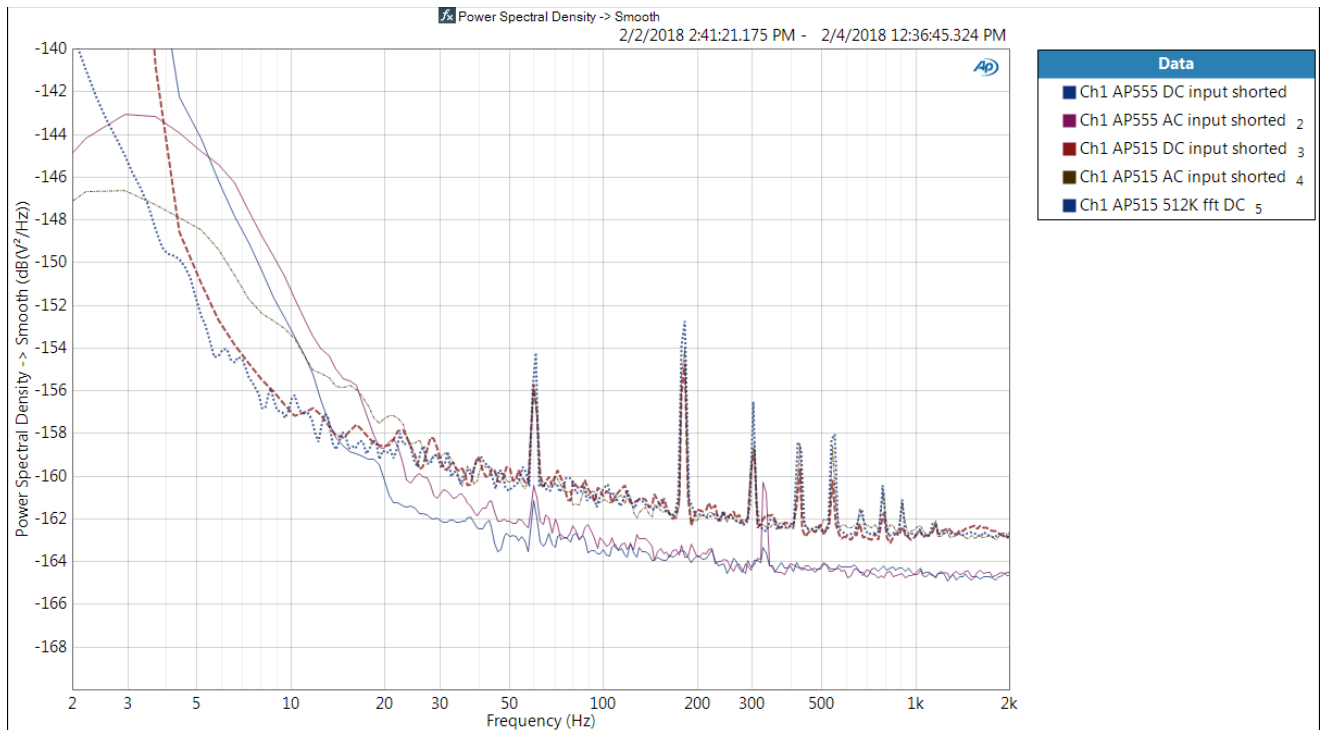

Figure 11 AP555 and AP515 instrument noise floors with input shorted PSD comparison (128K pt FFT 128 averages) (rev 3)

Looking at 2 kHz we can see that the AP555's noise floor PSD (Blue and Purple solid traces) is 2 dB  $V^2/Hz$  lower than the AP515's (dotted traces). As with the AP515, enabling the input high pass filter results in a slightly higher 1/f noise, i.e. the purple trace (AC coupled) is about 2 dB higher than the blue (DC coupled trace) at 10 Hz. If the data was plotted as ASD it would be 26 nV rt-Hz vs 21 nV rt-Hz at the 10 Hz frequency. If these curves were from parts being measured in the test fixture it would be a noise index (NI) of -43 dB and -45 dB, respectively. NI does not apply here, we're simply stating what the test jig and an AP555 can or can't measure.

The AP515's AC coupled PSD value (brown dotted curve) crosses the AP555's DC coupled curve at 10 Hz. In the 1/f dominated region (around 15 Hz and lower) the AP515 AC noise (brown dotted curve) is less than the AP555's AC coupled curve (purple) trace. At 3 Hz and below the high pass filter can be seen to reduce the noise.

Both AP units show lower 1/f noise with DC coupling. With a 128 k point FFT any DC at the input will start to raise the response below 5 Hz. This is seen in the AP555's solid blue curve and the AP515's dashed dark red curve. As with the AC coupled noise in the 1/f region, the AP515 performs better. In this case at 10 Hz the ASD is 14 nV rt-Hz. If this was from a resistor in the test jig it would correspond to a NI of -48 dB.<sup>2</sup>

One additional run was taken with the AP515 with a 512K point FFT and 128 averages. The factor of 4 increase means that the effect of DC on the input is now pushed down to below 2 Hz. As the dashed blue line in the above plot shows, we can see that the 1/f noise spectrum holds down to 2 Hz. Stated a bit differently, the data plotted for the 128K pt FFT (dark red dashed line) is only valid to 5 Hz; the data for the 512K pt FFT (blue dotted curve) is valid down to 2 Hz.

<sup>2</sup> That number is rederived elsewhere; the calculations here are from a newer set of measurements. In both cases the same results are obtained.

## MEASUREMENT OF RESISTORS CONNECTED TO THE AP INPUT

A couple of different resistors were connected to verify that readings fell within the range of expected values and to gain a sense of how test with the Wheatstone bridge might compare. As there is no applied voltage there theoretically is no excess noise and the  $1/f$  noise would be that of the AP.

Resistor connected to AP BNC (unbalanced) input 1 using small jig as shown on the channel 1 input (left side) of Figure 1.

### 10 K CARBON FILM (LEADED 1/4W), MANUF UNKNOWN

From the spare parts bin. This is the only test where the raw FFT and processed ASD will both be presented. For the remaining test only the processed result will be presented as there is not much insight gained from the raw FFT.

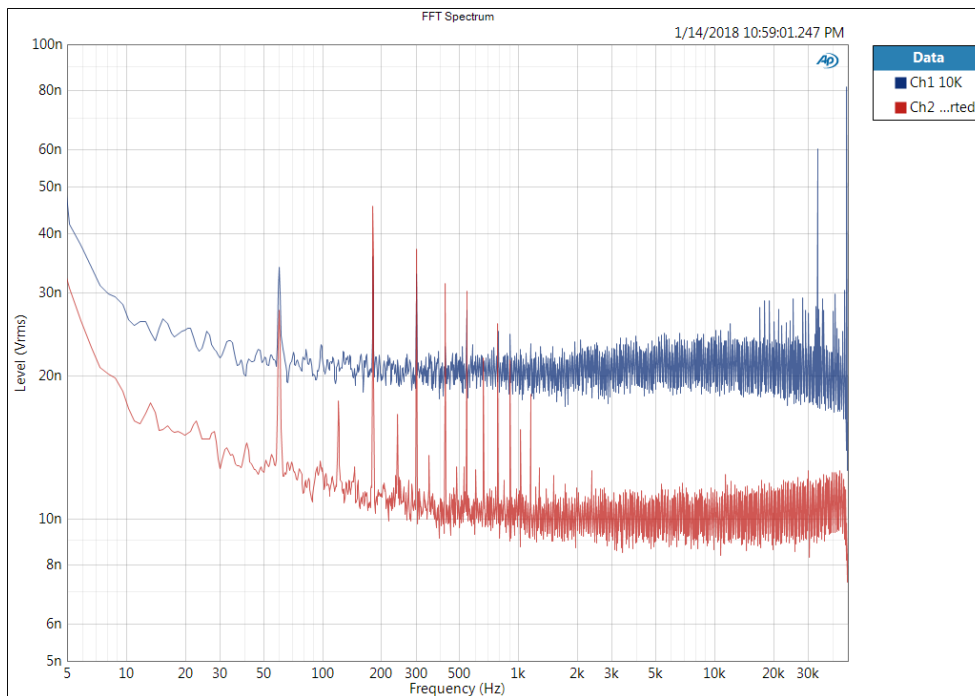

Figure 12 FFT results of 10K carbon film ch 1, ch 2 input shorted (unbalanced, using the small test jig)

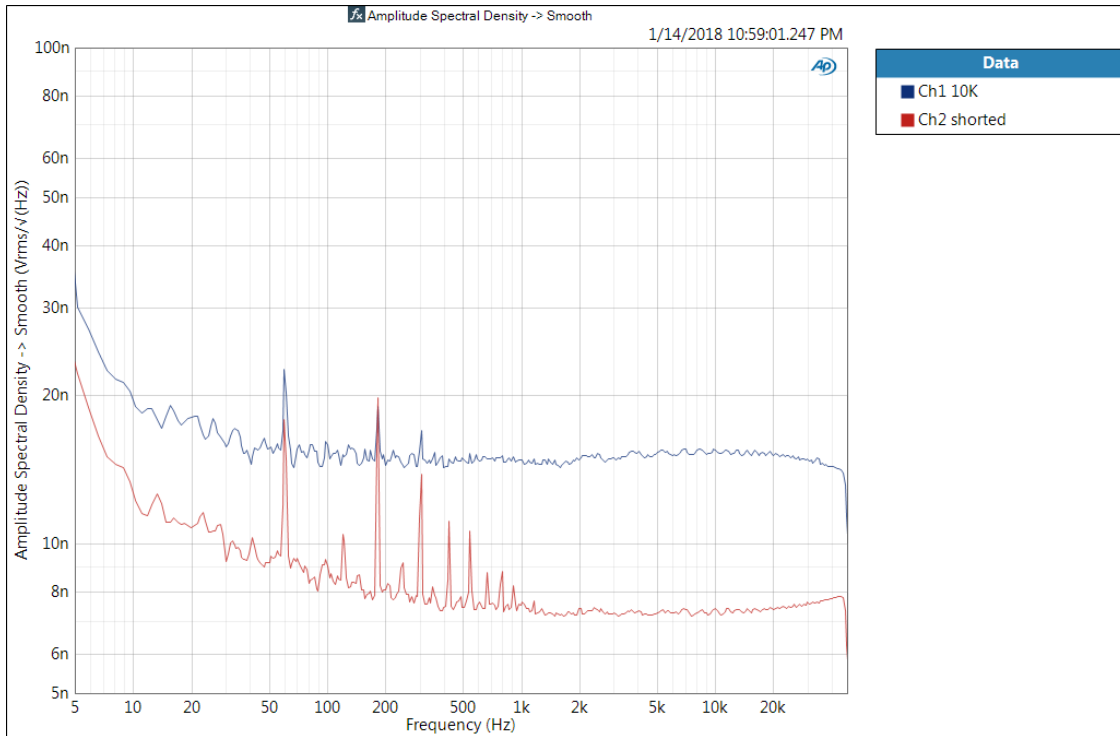

Figure 13 Smoothed ASD of 10K (ch 1) from Figure 11

ANALYSIS: 10K CARBON FILM

With 1.6  $\mu\text{V}$  RMS as the background noise floor of the AP for channel 1, and ideal noise of a 10K ohm resistor is 2.7  $\mu\text{V}$ , the RMS sum is 3.1  $\mu\text{V}$  which is in good agreement with the 3.23  $\mu\text{V}$  measured by the AP.

10K WIREWOUND

The wirewound part is from the Ohmite non-inductive parts series.



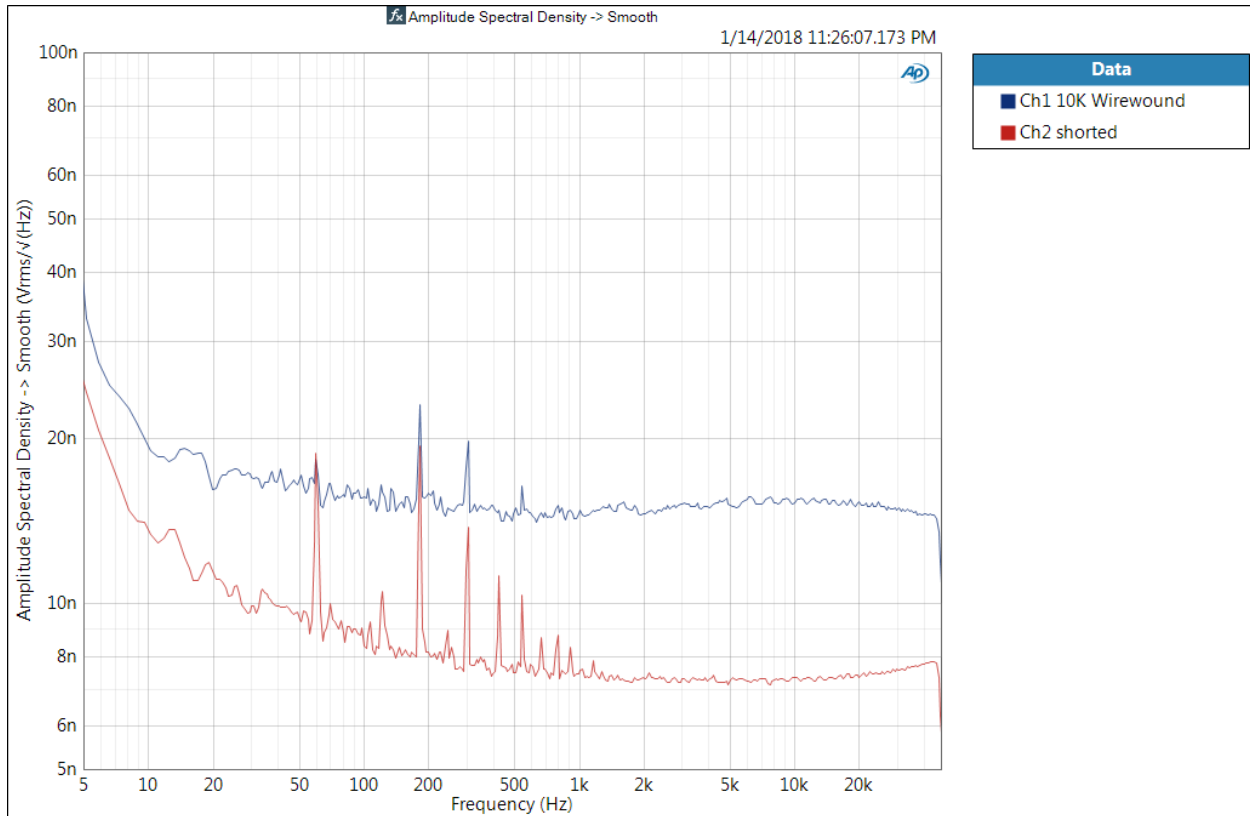

Figure 14 Smoothed ASD of Ohmite 10K Wirewound on input #1 (BNC small test jig)

#### ANALYSIS: 10K WIREWOUND

The match between the two identical resistance values is expected on a theoretical basis, and seemed to be born out by the actual testing. The measured noise was 3.24  $\mu$ V RMS.

#### MEASUREMENT OF RESISTORS CONNECTED BETWEEN AP OUTPUT AND AP INPUT

Test conditions for the AP using the small test jig that provides an input connection (right side of Figure 1)

- 1 KHz, 1V RMS gen level.
- 128 K FFT, 16 averages
- CH2 input shorted
- Unbalanced (BNC) connection

The AP termination impedance was in the high impedance mode (100K) so not a lot of current was flowing through the DUT in these tests.

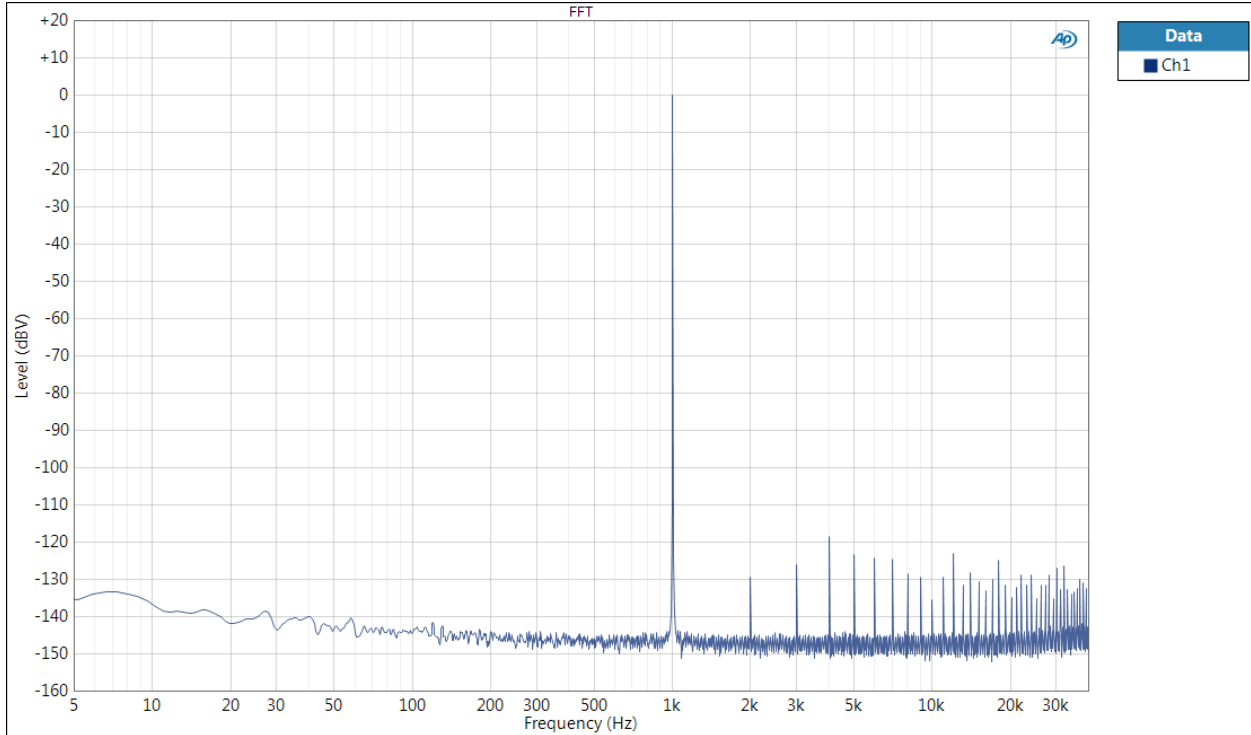

Figure 15 AP loopback (internal) .00088% THD+N (-101 dB) 100 k termination

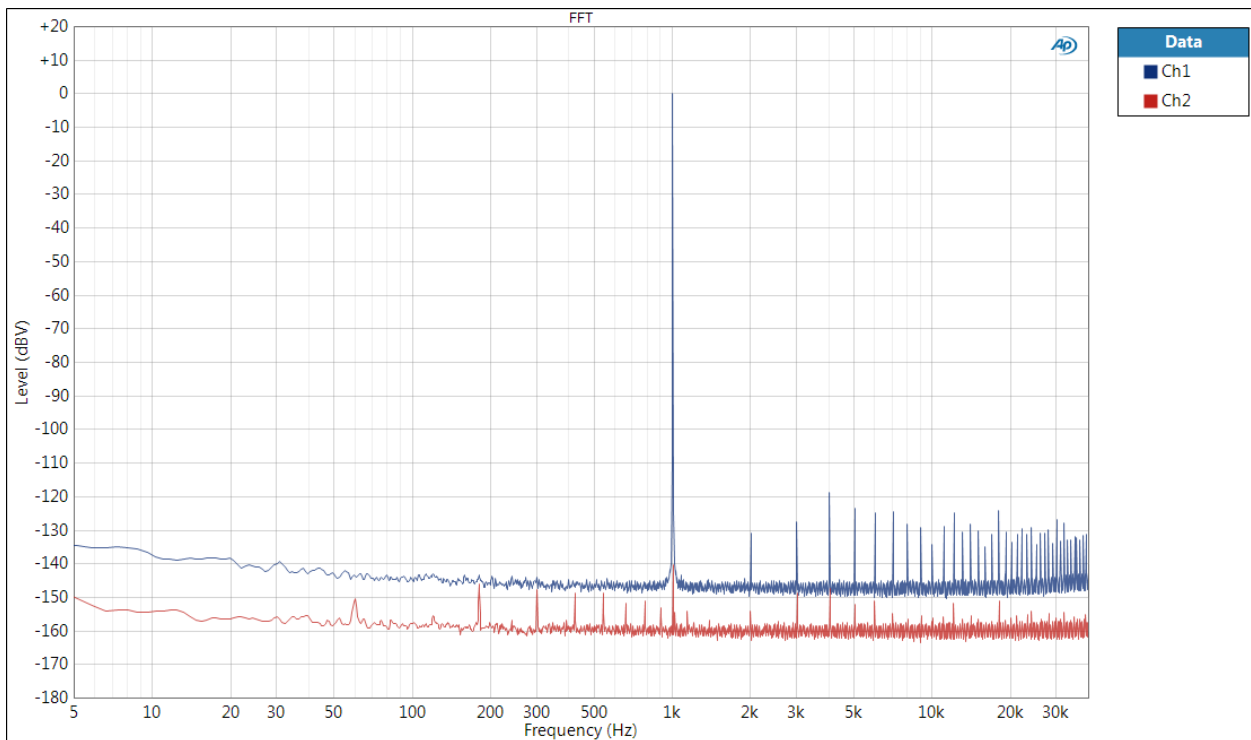

Figure 16 Small test jig AP loopback (blue) (.00082% THD+N, -102 dB) vs. input shorted (red) 100 k termination

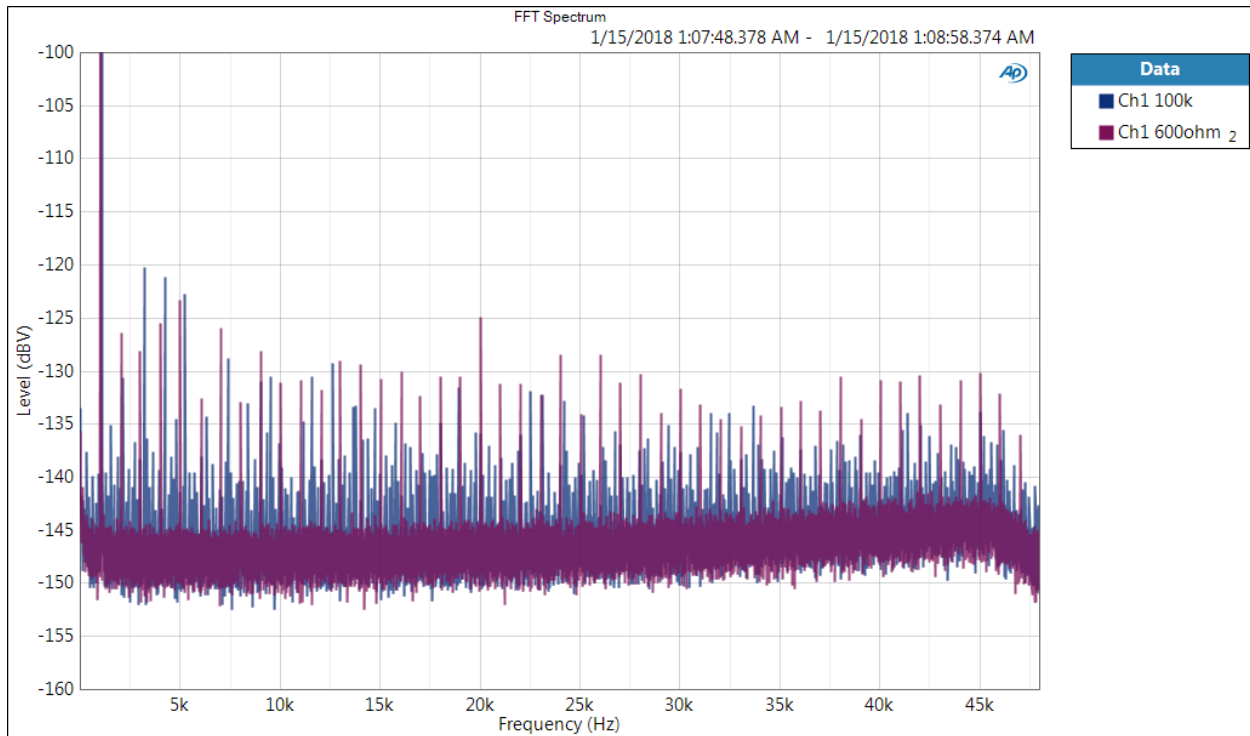

Figure 17 Small test jig loopback comparing 100K and 600 ohm termination. 128K point FFT, 16 averages. Linear frequency scale.

In Figure 16 the differences in the harmonics between 100K and 600 ohm termination can be seen. To produce this plot the frequency of the generator when capturing data for the 100K termination was increased to 1.05 kHz. Without this offset the data for the two runs overlaps and changes can not be easily determined. The THD+N does not change between the two termination values, but the spectral components of the harmonics do shift in level. Switching from 100K to 600 ohms the 2<sup>nd</sup> increases, the 3<sup>rd</sup> and 4<sup>th</sup> drop, and the 5<sup>th</sup> does not change much.

#### COMPONENT THD+N

Having characterized the AP, a few components were tried. The first was the 2.5 K wirewound. With 100K termination the THD+N was .00085% or -101 dB with the same 1V RMS generator level used for loopback. With the 600 ohm termination the generator level was increased to 5V to maintain a 0 dBV input level. THD+N remained the same.

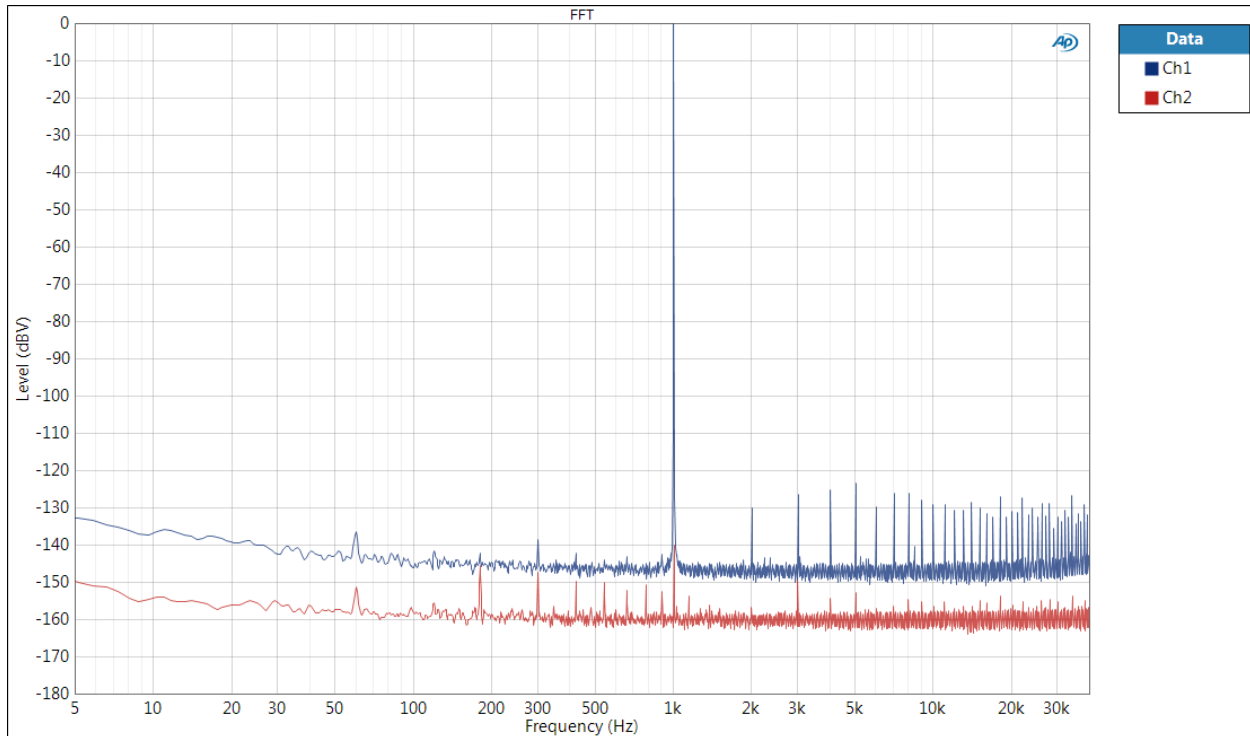

Figure 18 2.5K ohm Wirewound in between the AP output and input.

## ANALYSIS

In terms of distortion and Johnson noise the 2.5K wirewound reference bridge acts as an ideal resistor within the measurement limits of the AP515.

## TEST FIXTURE NOISE MEASUREMENT

128 K FFT, 16 averages

CH2 input shorted

Balanced output and input.

See Figure 6 and Figure 8 for AP and loopback noise.

## WITH BRIDGE BOARD SHORTED

Shorting + to – (input not connected) on the bridge board RDUT section the noise level measured by AP of 1.6  $\mu$ V is the same as seen with the AP input directly shorted.

The same measurement is also seen shorting the RREF bridge output.

It was noted that the wires in the MTA-100 connectors were not fully seated at first, leading to bad measurements (very high noise) from floating connections.

### POWER SUPPLY NOISE CHECK

For this test two 1uF film caps (Panasonic ECW-FD2W105K) were used to connect the V+ and V- lines to the test jig output (the caps being added to remove the large DC offset that would otherwise be present). The caps were first tested in the small jig on the AP (Figure 1) to verify they did not contribute any measurable noise or distortion.

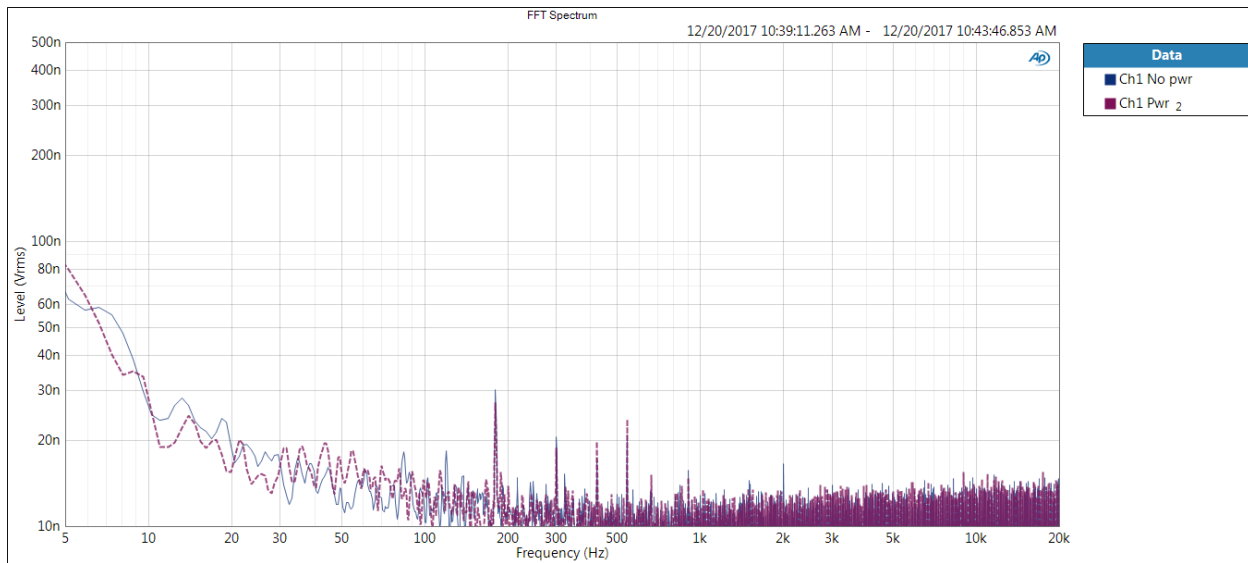

Figure 19 Noise check from batteries – none observed

### RREF NOISE MEASUREMENT

The *Seifert* paper provides background for the noise from a bridge configuration measured differentially. The *Märki* paper also provided inspiration for the set up being used.

The reference bridge is made from four 2.5K non-inductive wire wound resistors. With no power applied to the bridge each leg acts like 2 parallel resistors with a value of 1.25 K ohms. Using a 3 second average, 2.18 uV RMS noise is measured. The 3 second AP averaged input shorted noise is 1.65 uV RMS. The calculated Rnoise is .95 uV RMS, giving a theoretical measured value of 1.90 uV RMS vs the 2.18 uV RMS actually measured.

Two 9V batteries are used to power the bridge so that the common mode voltage output is small – 60 mV was measured. The actual voltage was measured as 18.6V, or 9.3V across each of the resistors (this value fluctuated with use and temperature).

With the bridge powered the noise voltage increases to 2.28 uV RMS (3 second average from the AP reading 64 times/sec). These numbers were derived by exporting the data shown in Figure 19 and analyzing 3 seconds worth

(from 8 to 11 and 13 to 16 for off and on states, respectively). This corresponds to 0.10 uV of excess noise across the entire measurement bandwidth.

For the spectrum 128K point FFT with 16 (or 128 when more accuracy was needed) averages is used with the AP\_Equiripple window. The input mode was changed from AC coupled to DC as that reduces to the low frequency AP515 contribution at 5 Hz from 50 nV to 40 nV. As can be seen in Figure 20 the reference bridge has the same noise level as the AP in the 1/f region. The Johnson noise is higher, as would be expected.

Looking at the scope plot no popcorn type noise was observed, as well as listening via the AP's monitor didn't reveal any pops. However the noise sound was not quite as uniform compared to the AP's internal noise. Recording the data to a .wav and playing it back did not produce the same difference heard from direct monitoring. Further listening tests are needed to determine if there are short term differences that are hidden by the long term averaging being used and/or the noise played through the monitor compares to the actual noise.

For 1/f noise analysis the AP should be DC coupled to minimize the AP's contribution. For RMS noise level AC coupling must be used as the DC offset from the input swamps the noise measurement.

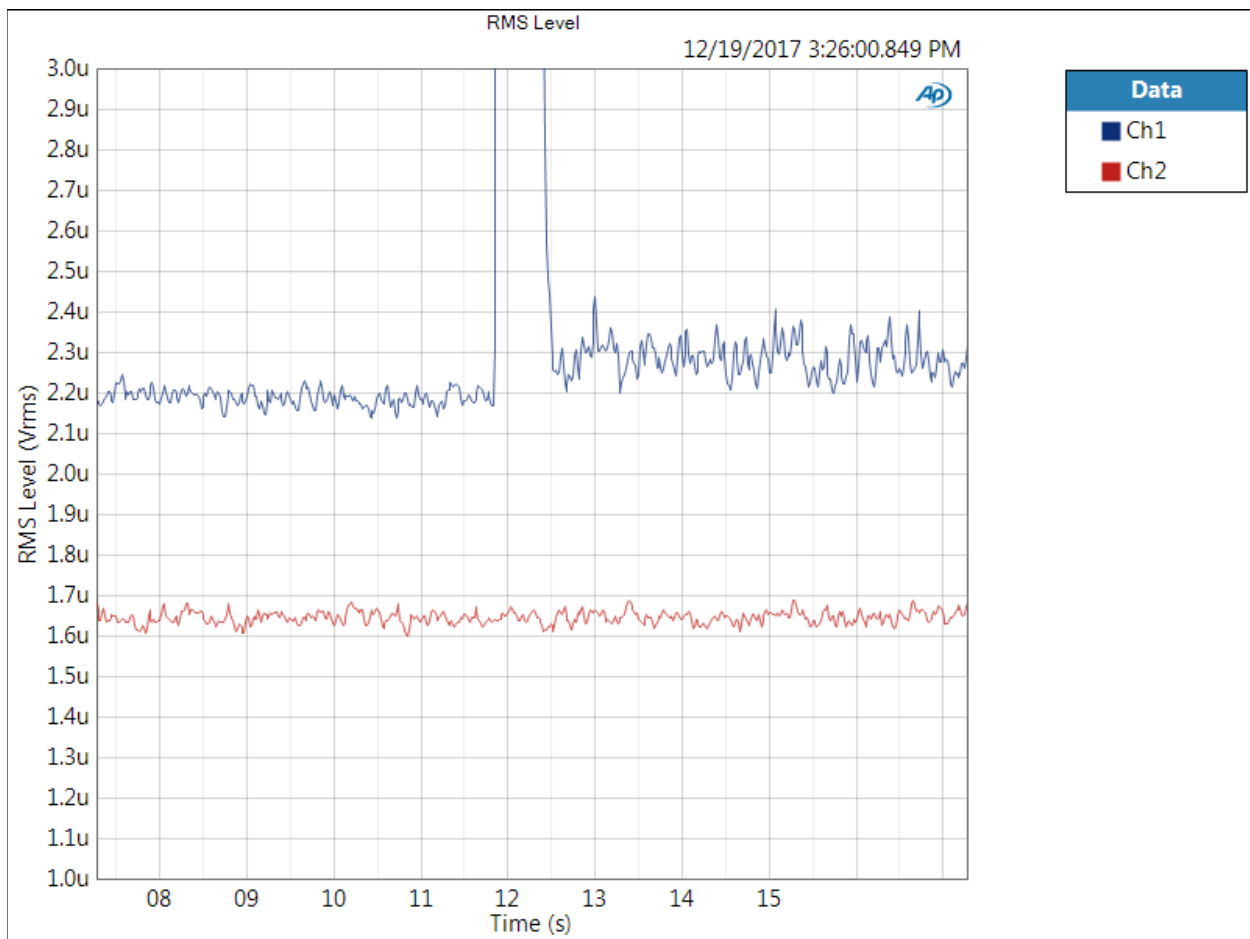

Figure 20 RMS level vs time for the RREF, left side no power, right side power applied around the 12 second mark (ch 2 is AP input shorted)

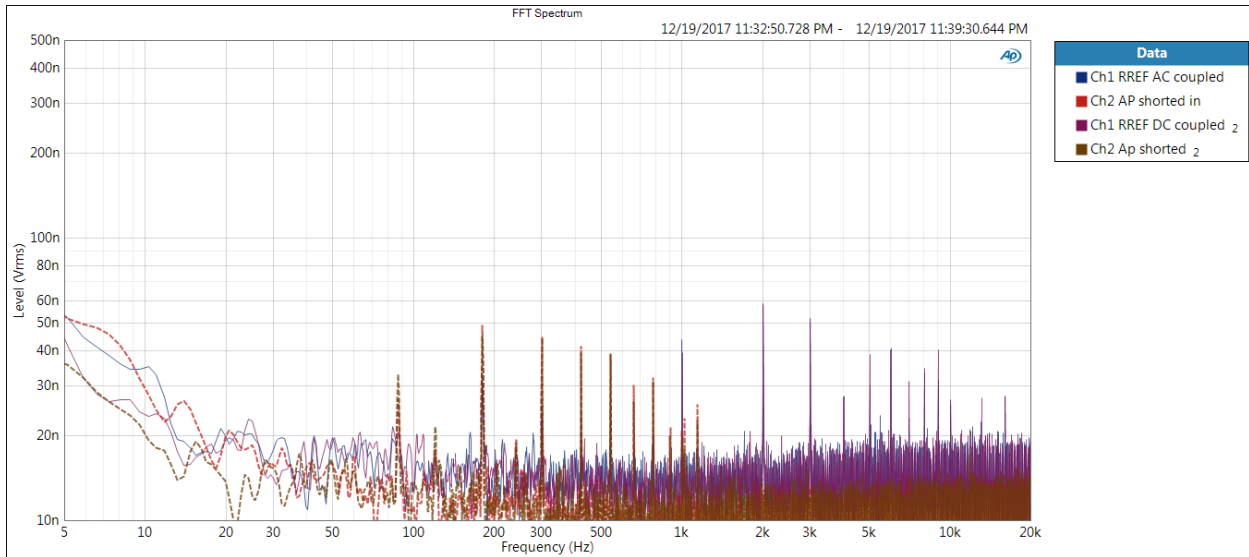

Figure 21 Comparison of AP515 AC vs DC coupling. Dashed line is ch2 – AP input shorted. Unprocessed 128K point FFT.

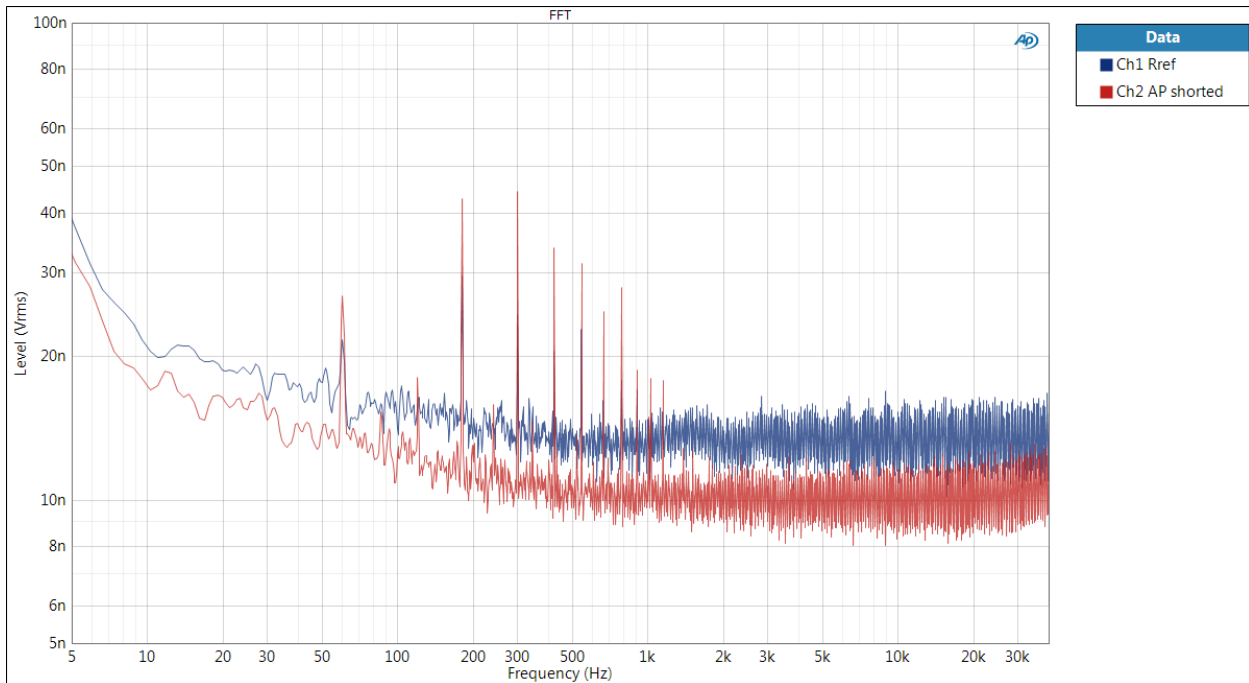

Figure 22 RREF unpowered (ch 1) and AP input shorted (ch2) (balanced connection to test jig) raw FFT results

The FFT length was shortened to 32K and 512 averages were performed to better observe the apparent ripple in the RREF noise spectrum. Figure 22 shows some ripple every 1.5 kHz, the cause of this was not assessed. The large low frequency is from the DC offset, with the smaller FFT size the windowing effect on that is now visible. This ripple is not as obvious with the smoothed results.

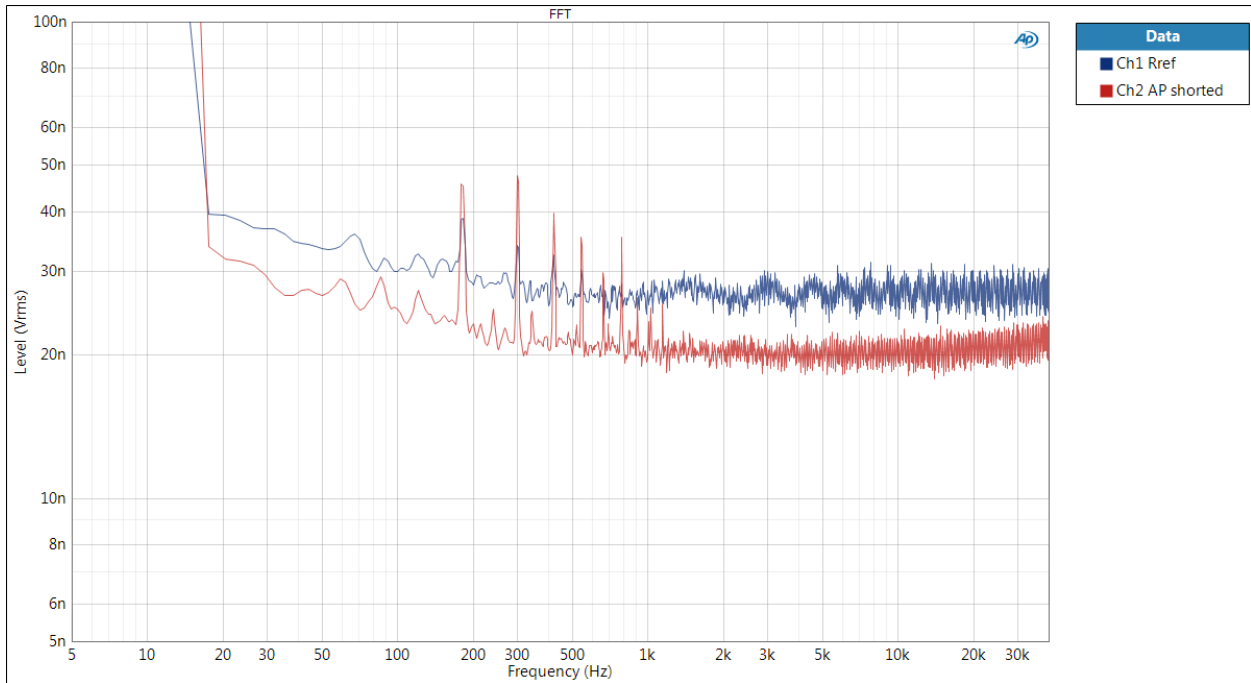

Figure 23 RREF unpowered (ch 1) and input shorted (ch2) (balanced) 32K FFT with 512 averages (small FFT size results in DC showing below 20 Hz)

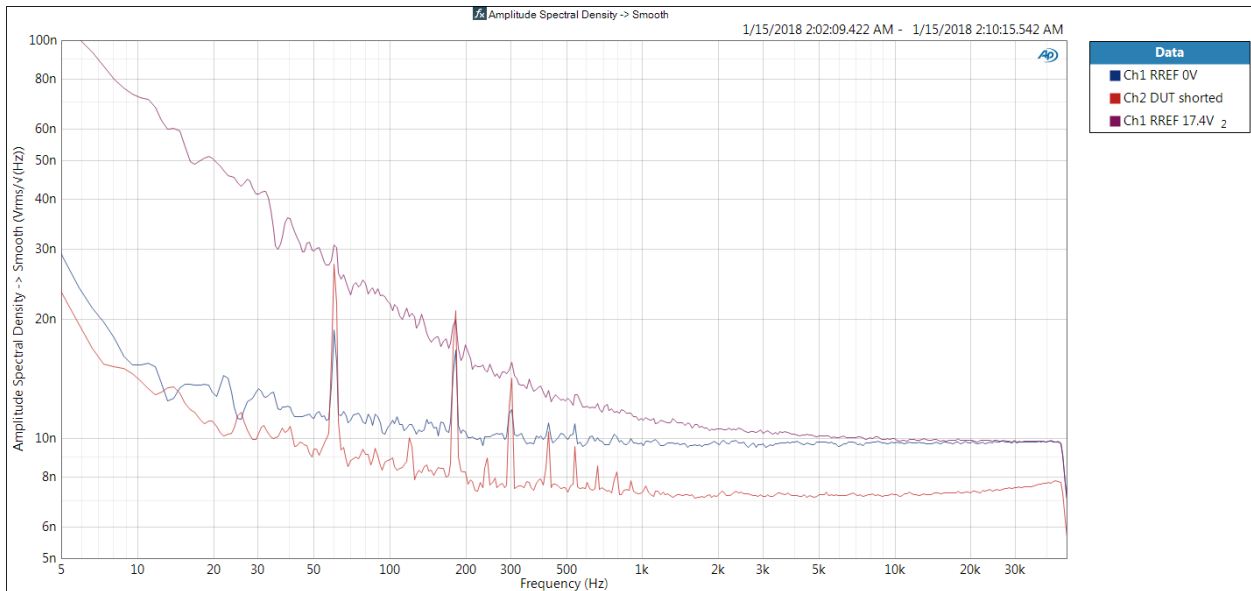

Figure 24 Increase in RREF 1/f noise with 17.4 VDC applied to bridge. Smoothed ASD results. (128K pt FFT)



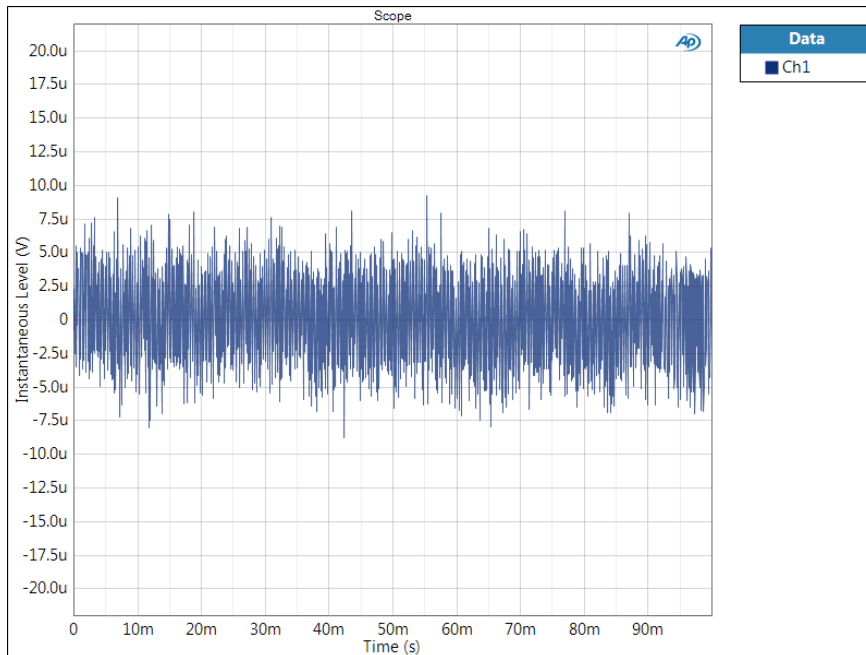

Figure 25 Scope trace of RREF bridge output with 18.5V applied

#### ANALYSIS: RREF 2.5K EXCESS NOISE

It was expected that the wirewound resistors would show very little excess noise. Figure 23 shows a large increase over the AP515 noise floor. This was verified by creating a DUT bridge with the 2.5K ohm parts and getting the same measurements (7%; averaged from the FFT results 2K to 10 KHz, 13.8 and 14.8  $\mu\text{V}$  RMS for the DUT and RREF), so it is not a problem in the RREF circuit hookup.<sup>3</sup>

The NI is calculated from the values in Figure 23 as:

- The spectral density is 72 nV/rt-Hz at 10 Hz
- The Johnson noise level is 9.8 nV/rt-Hz (not used for NI calculation, provided for informational use)
- Plugging 10Hz to 100 Hz and 72 nV/rt-Hz at 10 Hz to the spreadsheet and calculate the 1/f noise in a frequency decade, yielding .345  $\mu\text{V}$  RMS.

With 17.4 V applied this is .02  $\mu\text{V}/\text{V}$ , or a NI of -34 dB.

#### EXCESS NOISE MEASUREMENT WITH AC APPLIED

For these tests the AP generator is used to power the bridge. The generator frequency was set to 1 kHz. Two different levels were used, 60 mV and 6V RMS (17 V P-P).

It was expected that an AC voltage would create some 1/f noise but the test results don't seem to show any increase. Further research on this topic is needed, but the lack of noise is generally explained by the same theory

<sup>3</sup> Never say never. Extraordinary results require extraordinary explanation and there may yet be a more pedestrian explanation for this result.

that chopper stabilized amplifiers work under. Except in this case there's no subsequent demodulation so the noise power must still be distributed in the bandwidth of the signal. The first conjecture is that it's such a small amount of noise energy that it is "lost in the noise" when spread out across a wider bandwidth.

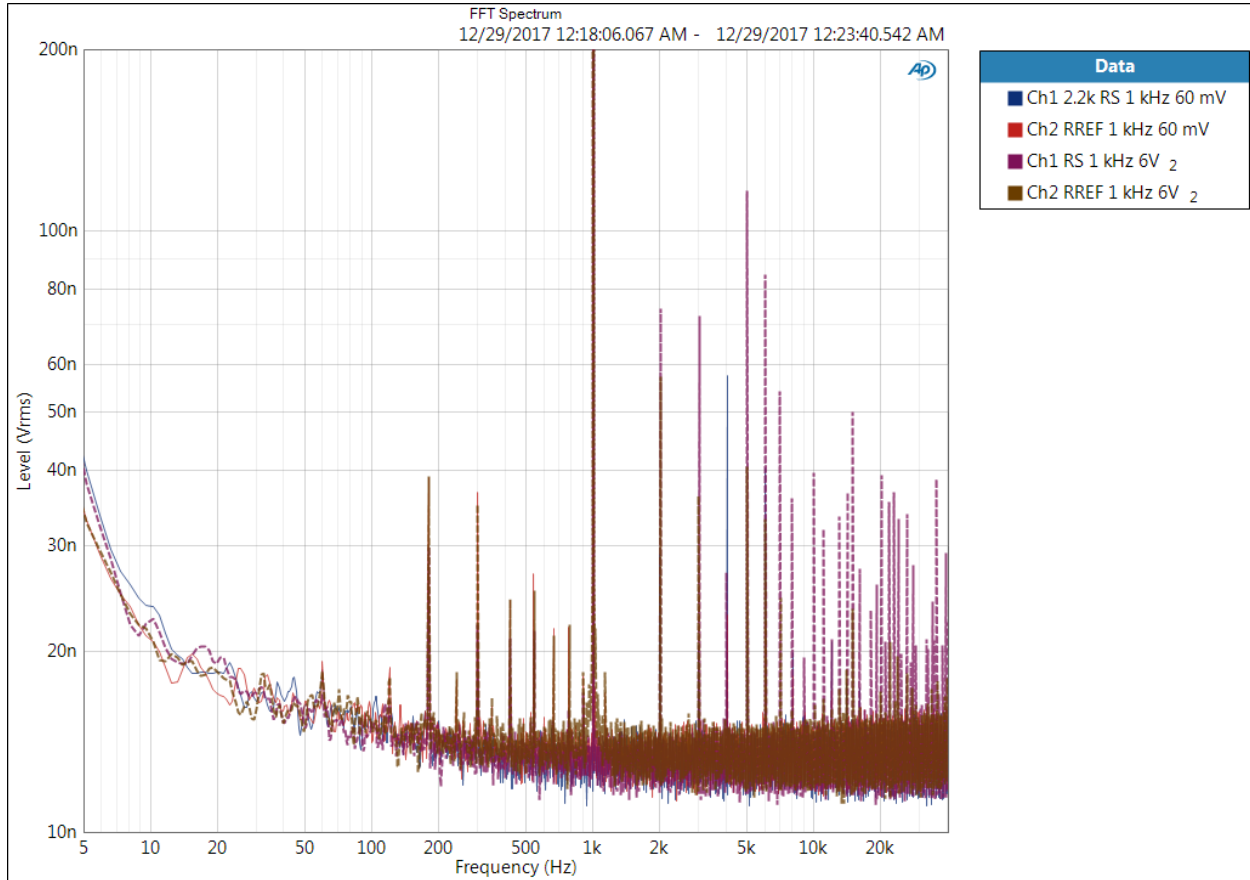

Figure 26 Spectrum using 1 kHz instead of DC for the bridge (128 K pt FFT, 128 averages)

## OP AMP VALIDATION

The validation board uses wirewound resistors that were shown via testing to have minimal excess noise (as will be noted in Part 3 not all of them met that expectation). Figure 29 shows the stuffing options and parts used for the generic op-amp board described in Part 1.

When the box was built the available bulkhead style BNC connectors were isolated ground. As an experiment the ground was not tied to the case but run the main PCB ground, which connected to the case separately. This resulted in the pickup of a nearby radio station and 60 Hz related interference. Grounding the connector to the case at the point of entry solved that noise pickup, but would not be as good of connection as grounded BNC bulkhead connectors.

The board was built with a NE 5532 as it was available in an 8 pin DIP package, which would allow other op-amps to be plugged in to the validation board. The 1K limiting resistor (R1) in the non-inverting configuration was included, though the Texas Instruments NE5532 used does not have a datasheet requirement for it.

Worth noting is the comment in *Self* that not all manufacturers' NE5532 op-amps perform the same for THD+N. No manufacturer specifies NE5532 THD+N performance so it's not clear if the NE5532's relatively good THD+N performance for a low cost part is a happy accident or not. It does suggest that anything built with NE5532 must be fully production tested for THD+N performance.<sup>4</sup> The NE5534 also lacks performance information, though the TI datasheet shows .002% THD+N as typical. The On Semiconductor datasheet does not have the plot.

Another oddity of the NE5532 is no manufacturer provides a SPICE model for it. A SPICE model is provided for TI's NE5534 but it's not obvious how close that part's model is to a NE5532. There is also uncertainty about the choice of compensation capacitor value that would be needed to make the NE5534 model look like a NE5532 (which is internally compensated). The NE5534 SPICE model lacks inclusion of 1/f noise in the model so it is not useful to simulating the system 1/f noise performance.

## PERFORMANCE CHECK

With 1K and 10K resistors, the gains are 10 (inverting) and 11 (non-inverting). The resistors are Ohmite WN (non inductive wirewound) with 1% tolerance.

Input 200 mV RMS 1 kHz:

- Output non-inverting: 2.26 V RMS THD+N 0.00088% (-101 dB)
- Output inverting: 1.88 V RMS [check why this is too low] THD+N .00087%

Input with AP gen off:

- Output non-inverting: 17.5 uV RMS
- Output inverting: 14.1 uV RMS

Input shorted at test fixture:

- Output non-inverting: 17.1 uV RMS
  - SPICE predicts 3.8 uV more noise (from the input resistor), less than is measured. However the total value is larger than the 12.3 uV calculated from using ideal op amps
- Output inverting: 14.2 uV RMS
  - With ideal op-amps 8.6 uV is calculated with SPICE. With the NE5534 10.2 uV is calculated.
  - [check why noise 40% higher than calculated – maybe some shielding/grounding issues still?]

---

<sup>4</sup> Some discussions in forums suggest that things have changed after *Self's* assessment, but so far no direct study of this issue was found.

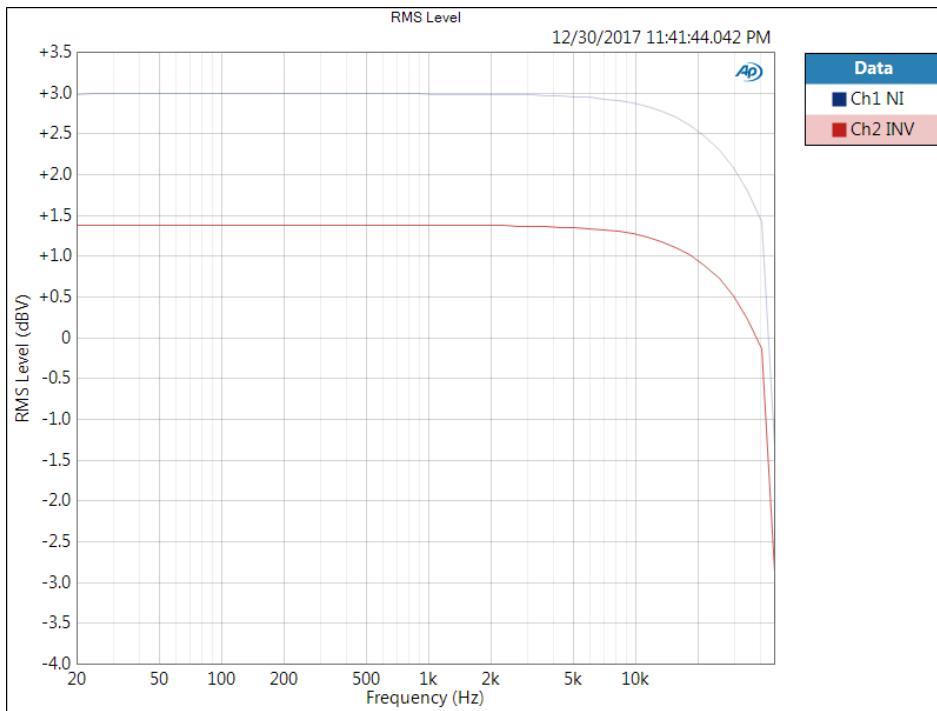

Figure 27 Frequency sweep

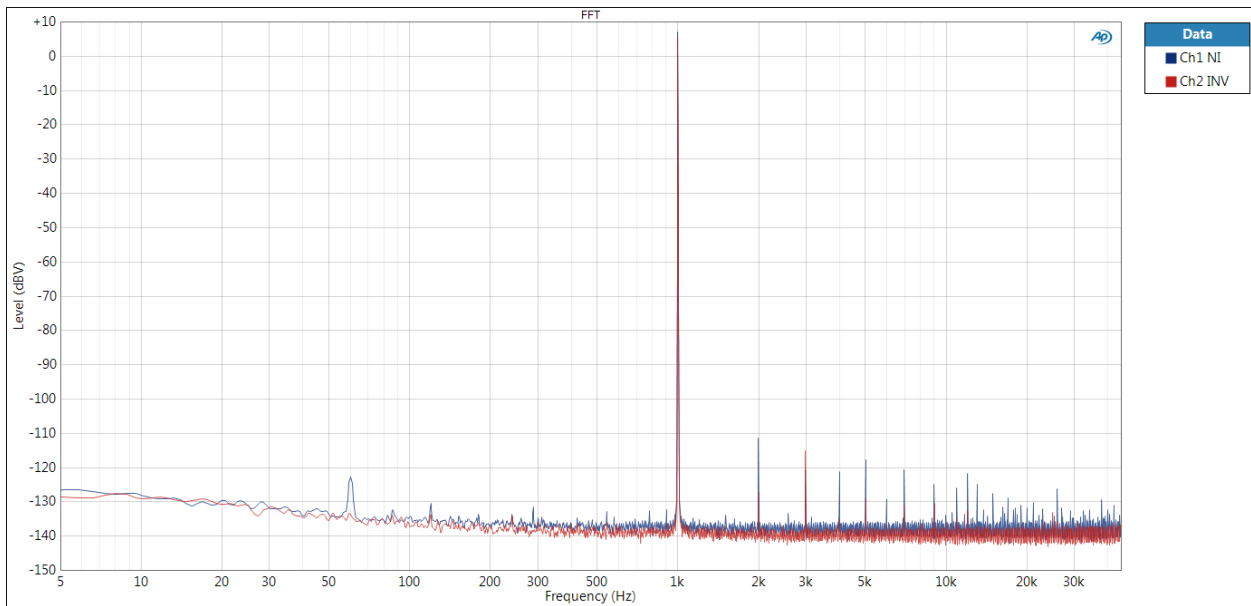

Figure 28 200 mV RMS input. 128 k pt FFT, 16 averages (AC coupled) NE5532 and wirewound resistors

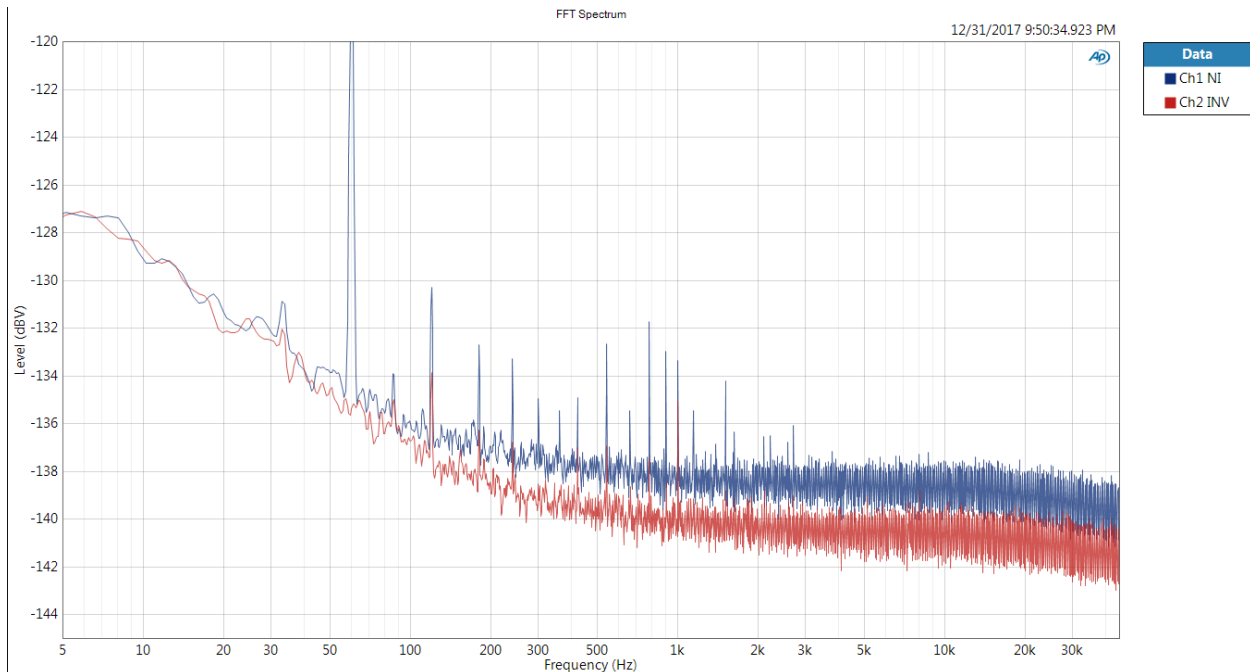

Figure 29 128K pt FFT 128 averages gen off

#### ANALYSIS: OP-AMP VERIFICATION BOARD

A detailed look at the  $1/f$  and Johnson noise levels was not performed as the total noise measured by the AP was about 40% higher than expected. Further work is needed to verify that op-amp test is not introducing external noise/measurement error.

#### SUMMARY

For resistor noise measurement the test fixture appears to be usable and capable of supporting the measurements within the capabilities of the AP515. The simple jig mounted to the BNC connectors of Figure 1 allows for an easy check of individual components.

The following items were noted:

- 60 Hz harmonics can appear in some configurations, but seem to be related to the AP515 in at least some cases as they appear with the input shorted.
- The laptop used with the AP515 appears to occasionally create a ground loop, with frequencies showing as multiple of 1 KHz (or aliased down to 1 KHz). Running from the laptop's batteries removes the problem.
- The test fixture connectors must be well seated, but even with this mechanical effects can show up in the signal. This seemed particularly true for the DUT connector.<sup>5</sup>

<sup>5</sup> While this fixture was planned as multiple PCBs to allow changing parts around easily, a second version should probably combine most of the capability on to a single PCB board fabricated specifically for these tests (i.e. not constructed from stock/generic breadboards).

- Proper shielding and grounding is a must.
- The signal levels used with the AP515 can change the THD+N readings by a few dB depending on where the AP's outputs and inputs are in their respective autoranging scales. It will be important to keep this in mind for future measurements.

REFERENCES

Please see Part 1 for a complete list of references.

APPENDIX A

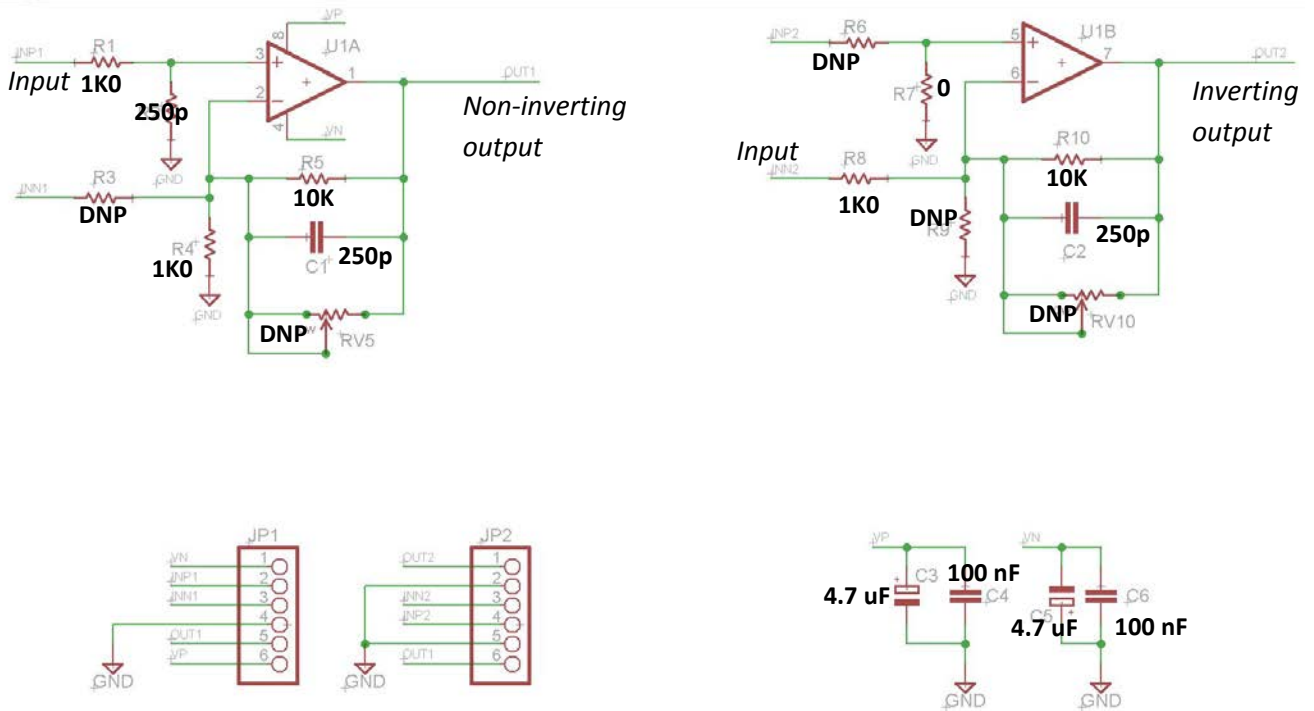

Figure 30 Op-amp board configured for design validation